

Features

- NPN + PNP Combination
- $BV_{CEO} > 12$ (-12)V
- $BV_{EBO} > 7$ (-7)V
- Continuous Collector Current $I_C = 5$ (-3.5)A
- $V_{CE(sat)} < 32$ (-70)mV @ 1A
- $R_{CE(sat)} = 25$ (45)m Ω
- **Totally Lead-Free & Fully RoHS Compliant (Notes 1 & 2)**
- **Halogen and Antimony Free. "Green" Device (Note 3)**
- **Qualified to AEC-Q101 Standards for High Reliability**

Description

Advanced process capability has been used to achieve this high performance device. Combining NPN and PNP transistors in the SOT26 package provides a compact solution for the intended applications.

Mechanical Data

- Case: SOT26
- Case Material: Molded Plastic, "Green" Molding Compound; UL Flammability Classification Rating 94V-0
- Moisture Sensitivity: Level 1 per J-STD-020
- Terminals: Finish – Matte Tin Plated Leads, Solderable per MIL-STD-202, Method 208 @3
- Weight: 0.015 grams (Approximate)

Applications

- MOSFET and IGBT Gate Driving
- Motor Drive

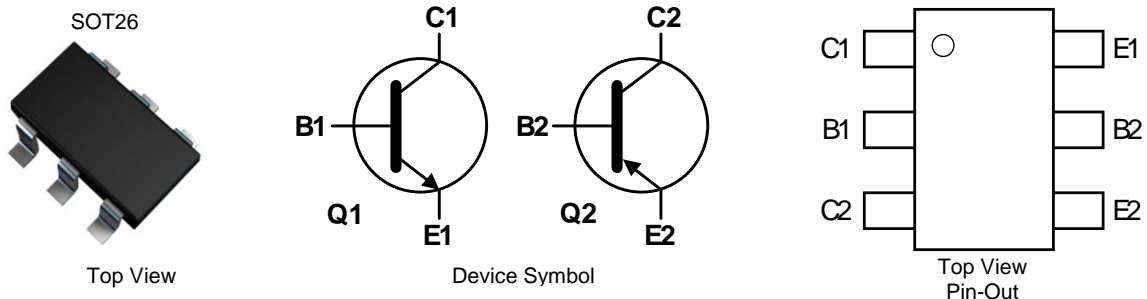

Ordering Information (Note 4)

Product	Compliance	Marking	Reel size (inches)	Tape width (mm)	Quantity per reel
ZXTC2061E6TA	AEC-Q101	2061	7	8	3,000

- Notes:
1. No purposely added lead. Fully EU Directive 2002/95/EC (RoHS) & 2011/65/EU (RoHS 2) compliant.
 2. See http://www.diodes.com/quality/lead_free.html for more information about Diodes Incorporated's definitions of Halogen- and Antimony-free, "Green" and Lead-free.
 3. Halogen- and Antimony-free "Green" products are defined as those which contain <900ppm bromine, <900ppm chlorine (<1500ppm total Br + Cl) and <1000ppm antimony compounds.
 4. For packaging details, go to our website at <http://www.diodes.com/products/packages.html>.

Marking Information

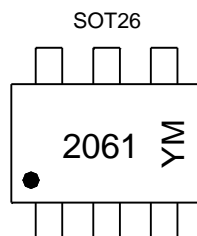

2061 = Product Type Marking Code
 YM = Date Code Marking
 Y or \bar{Y} = Year (ex: C = 2015)
 M or \bar{M} = Month (ex: 9 = September)

Date Code Key

Year	2015	2016	2017	2018	2019	2020	2021	2022	2023	2024	2025	
Code	C	D	E	F	G	H	I	J	K	L	M	
Month	Jan	Feb	Mar	Apr	May	Jun	Jul	Aug	Sep	Oct	Nov	Dec
Code	1	2	3	4	5	6	7	8	9	O	N	D

Absolute Maximum Ratings – Q1 (NPN Transistor) (@T_A = +25°C, unless otherwise specified.)

Characteristic	Symbol	Value	Unit
Collector-Base Voltage	V _{CBO}	20	V
Collector-Emitter Voltage	V _{CEO}	12	V
Emitter-Base Voltage	V _{EBO}	7	V
Continuous Collector Current	I _C	5	A
Peak Pulsed Collector Current	I _{CM}	12	A
Base Current	I _B	1	A

Absolute Maximum Ratings – Q2 (PNP Transistor) (@T_A = +25°C, unless otherwise specified.)

Characteristic	Symbol	Value	Unit
Collector-Base Voltage	V _{CBO}	-12	V
Collector-Emitter Voltage	V _{CEO}	-12	V
Emitter-Base Voltage	V _{EBO}	-7	V
Continuous Collector Current	I _C	-3.5	A
Peak Pulsed Collector Current	I _{CM}	-10	A
Base Current	I _B	-1	A

Thermal Characteristics (@T_A = +25°C, unless otherwise specified.)

Characteristic	Symbol	Value	Unit
Power Dissipation Linear Derating Factor	P _D	(Notes 5 & 9)	0.7
		(Notes 6 & 9)	5.6
		(Notes 6 & 10)	0.9
		(Notes 7 & 9)	7.2
		(Notes 8 & 9)	1.1
		(Notes 8 & 9)	8.8
Thermal Resistance, Junction to Ambient	R _{θJA}	(Notes 5 & 9)	1.1
		(Notes 6 & 9)	8.8
		(Notes 6 & 10)	1.1
		(Notes 7 & 9)	8.8
		(Notes 8 & 9)	1.7
Thermal Resistance, Junction to Lead	R _{θJL}	13.6	°C/W
Operating and Storage Temperature Range	T _J , T _{STG}	-55 to +150	°C

ESD Ratings (Note 12)

Characteristic	Symbol	Value	Unit	JEDEC Class
Electrostatic Discharge - Human Body Model	ESD HBM	4,000	V	3A
Electrostatic Discharge - Machine Model	ESD MM	400	V	C

- Notes:
- For a device surface mounted on 15mm x 15mm FR4 PCB with high coverage of single sided 1oz copper, in still air conditions; the device is measured when operating in a steady-state condition.
 - Same as Note 5, except the device is surface mounted on 25mm x 25mm 1oz copper.
 - Same as Note 5, except the device is surface mounted on 50mm x 50mm 2oz copper.
 - Same as Note 7, except the device is measured at t < 5 seconds.
 - For device with one active die, both collectors attached to a common heatsink.
 - For device with two active dice running at equal power, split heatsink 50% to each collector.
 - Thermal resistance from junction to solder-point (at the end of the collector lead).
 - Refer to JEDEC specification JESD22-A114 and JESD22-A115.

Thermal Characteristics and Derating Information

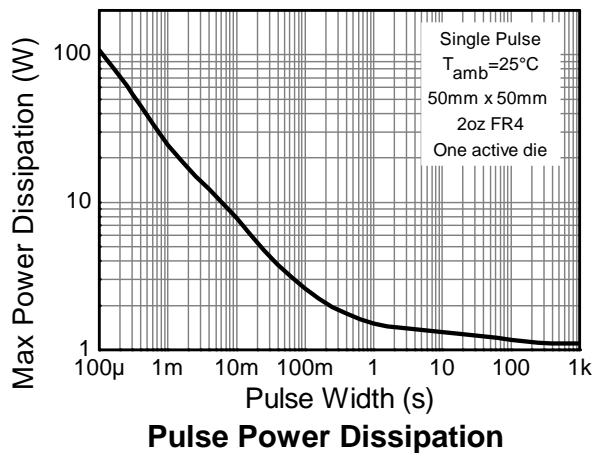
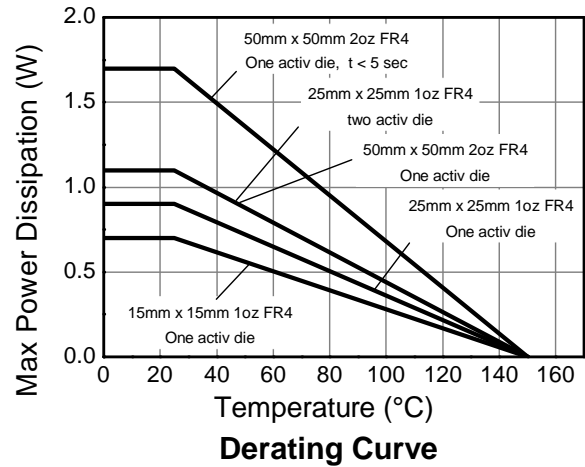
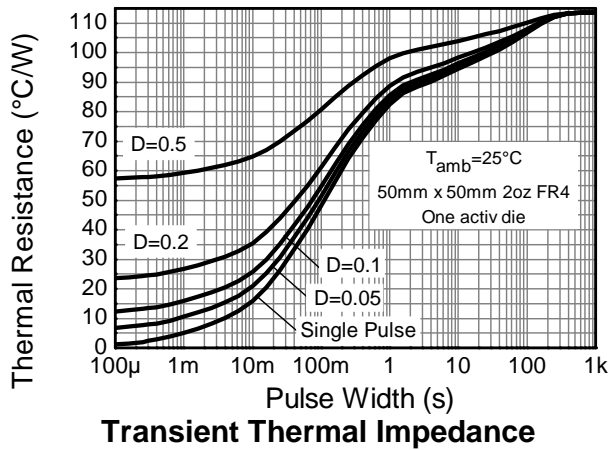
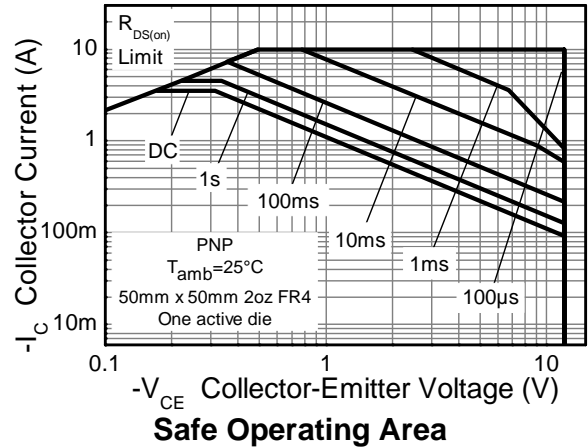
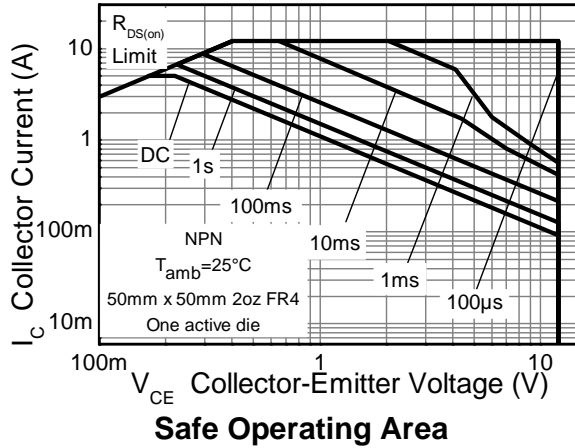

Electrical Characteristics – Q1 (NPN Transistor) (@T_A = +25°C, unless otherwise specified.)

Characteristic	Symbol	Min	Typ	Max	Unit	Test Condition
OFF CHARACTERISTICS						
Collector-Base Breakdown Voltage	BV _{CBO}	20	40	—	V	I _C = 100μA, I _E = 0
Collector-Emitter Breakdown Voltage (Note 13)	BV _{CEO}	12	17	—	V	I _C = 10mA, I _B = 0
Emitter-Base Breakdown Voltage	BV _{EBO}	7	8.4	—	V	I _E = 100μA, I _C = 0
Collector Cut-Off Current	I _{CBO}	—	<1	50 0.5	nA μA	V _{CB} = 20V V _{CB} = 20V, T _A = +100°C
Collector Cut-Off Current	I _{EBO}	—	<1	50	nA	V _{EB} = 5.6V
ON CHARACTERISTICS (Note 13)						
DC Current Gain	h _{FE}	500 480 260	800 750 390	1,500	—	I _C = 10mA, V _{CE} = 2V I _C = 1.0A, V _{CE} = 2V I _C = 5A, V _{CE} = 2V
Collector-Emitter Saturation Voltage	V _{CE(sat)}	—	32 50 65 145	40 60 80 180	mV	I _C = 1.0A, I _B = 100mA I _C = 1.0A, I _B = 10mA I _C = 2.0A, I _B = 40mA I _C = 5A, I _B = 100mA
Base-Emitter Saturation Voltage	V _{BE(sat)}	—	920	1,000	mV	I _C = 5A, I _B = 100mA
Base-Emitter Turn-On Voltage	V _{BE(on)}	—	810	900	mV	I _C = 5A, V _{CE} = 2V
SMALL SIGNAL CHARACTERISTICS						
Output Capacitance	C _{obo}	—	26	35	pF	V _{CB} = 10V, f = 1.0MHz
Current Gain-Bandwidth Product	f _T	—	260	—	MHz	V _{CE} = 10V, I _C = 50mA, f = 100MHz
Delay Time	t _d	—	71	—	ns	V _{CC} = 10V, I _C = 1A, I _{B1} = -I _{B2} = 10mA
Rise Time	t _r	—	70	—	ns	
Storage Time	t _s	—	233	—	ns	
Fall Time	t _f	—	72	—	ns	

Electrical Characteristics – Q2 (PNP Transistor) (@T_A = +25°C, unless otherwise specified.)

Characteristic	Symbol	Min	Typ	Max	Unit	Test Condition
OFF CHARACTERISTICS						
Collector-Base Breakdown Voltage	BV _{CBO}	-12	-35	—	V	I _C = -100μA, I _E = 0
Collector-Emitter Breakdown Voltage (Note 13)	BV _{CEO}	-12	-25	—	V	I _C = -10mA, I _B = 0
Emitter-Base Breakdown Voltage	BV _{EBO}	-7	-8.4	—	V	I _E = -100μA, I _C = 0
Collector Cut-Off Current	I _{CBO}	—	< -1	-50 -0.5	nA μA	V _{CB} = -12V V _{CB} = -12V, T _A = +100°C
Collector Cut-Off Current	I _{EBO}	—	< -1	-50	nA	V _{EB} = -5.6V
ON CHARACTERISTICS (Note 13)						
DC Current Gain	h _{FE}	500 290 75	800 450 100	1500	—	I _C = -10mA, V _{CE} = -2V I _C = -1.0A, V _{CE} = -2V I _C = -3.5A, V _{CE} = -2V
Collector-Emitter Saturation Voltage	V _{CE(sat)}	—	-55 -170 -220 -150	-70 -265 -360 -200	mV	I _C = -1.0A, I _B = -100mA I _C = -1.0A, I _B = -10mA I _C = -2.0A, I _B = -40mA I _C = -3.5A, I _B = -350mA
Base-Emitter Saturation Voltage	V _{BE(sat)}	—	-955	-1,050	mV	I _C = -3.5A, I _B = -350mA
Base-Emitter Turn-On Voltage	V _{BE(on)}	—	-830	-900	mV	I _C = -3.5A, V _{CE} = -2V
SMALL SIGNAL CHARACTERISTICS						
Output Capacitance	C _{obo}	—	17	25	pF	V _{CB} = -10V, f = 1.0MHz
Current Gain-Bandwidth Product	f _T	—	310	—	MHz	V _{CE} = -10V, I _C = -50mA, f = 100MHz
Delay Time	t _d	—	41	—	ns	V _{CC} = -10V, I _C = -1A, I _{B1} = -I _{B2} = -10mA
Rise Time	t _r	—	62	—	ns	
Storage Time	t _s	—	179	—	ns	
Fall Time	t _f	—	65	—	ns	

Note: 13. Measured under pulsed conditions. Pulse width ≤ 300μs. Duty cycle ≤ 2%.

Typical Electrical Characteristics – Q1 (NPN Transistor) (@T_A = +25°C, unless otherwise specified.)

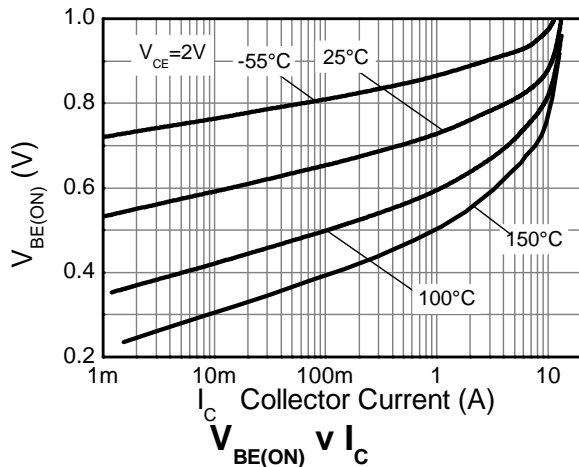
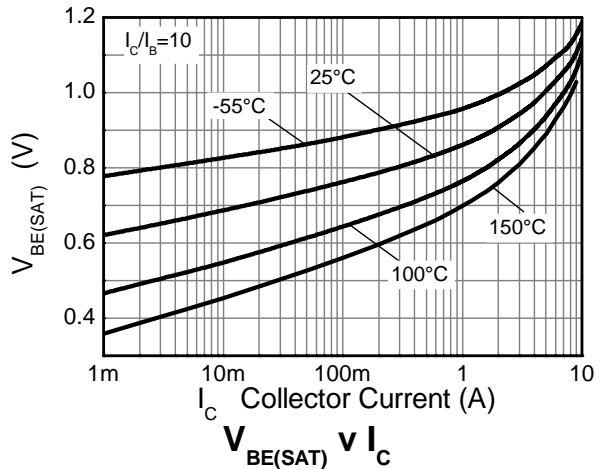
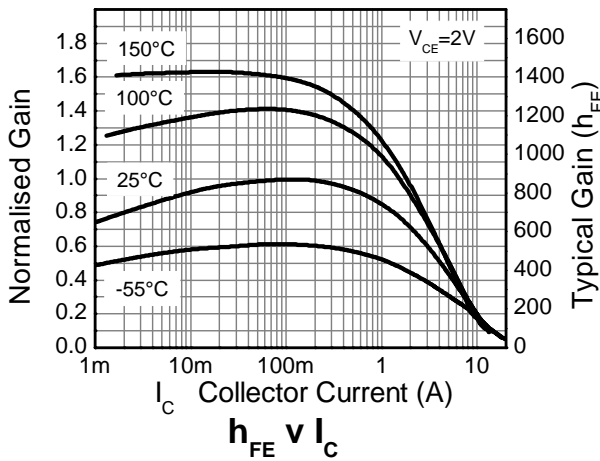
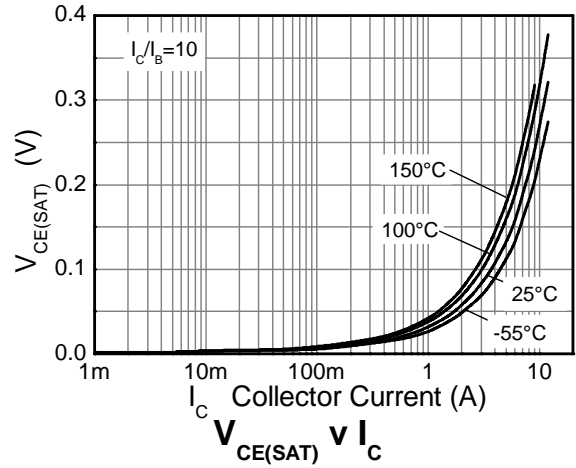
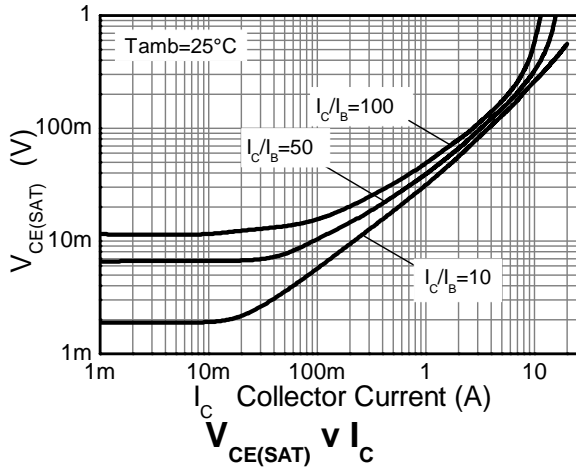

Typical Electrical Characteristics – Q2 (PNP Transistor) (@T_A = +25°C, unless otherwise specified.)

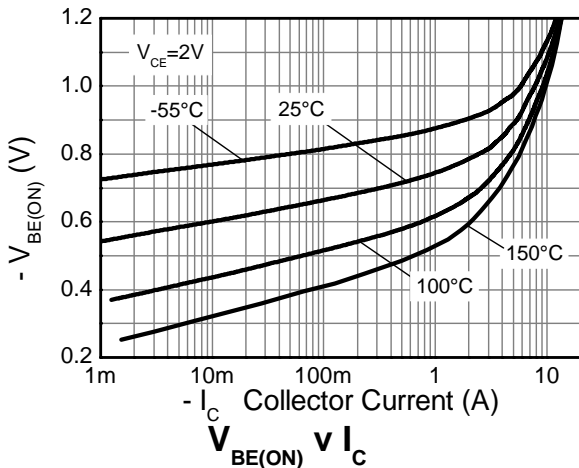
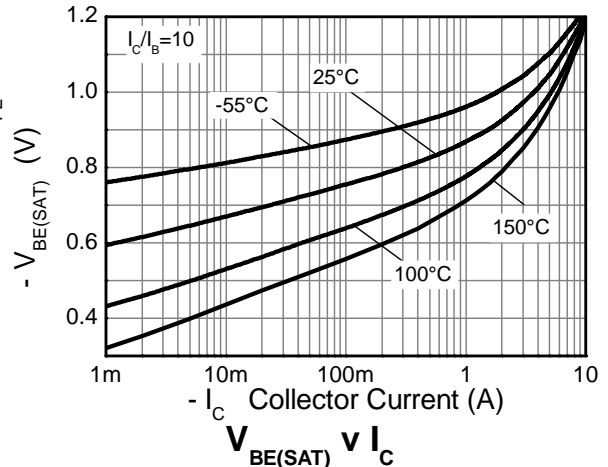
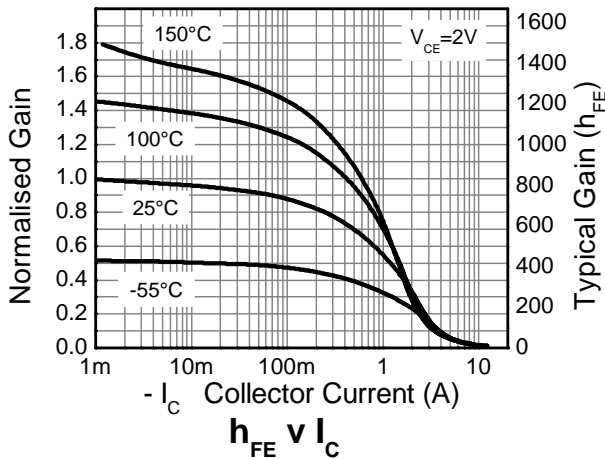
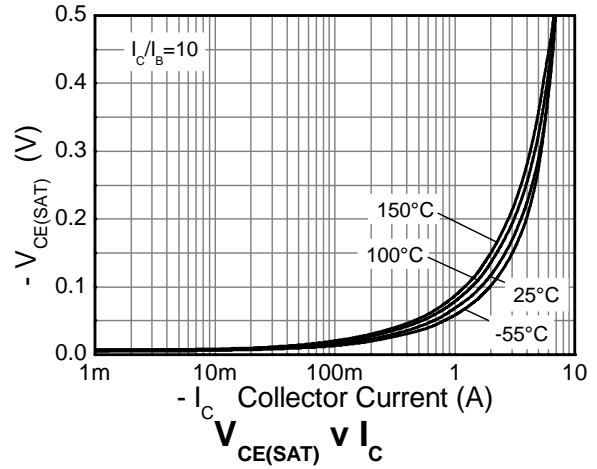
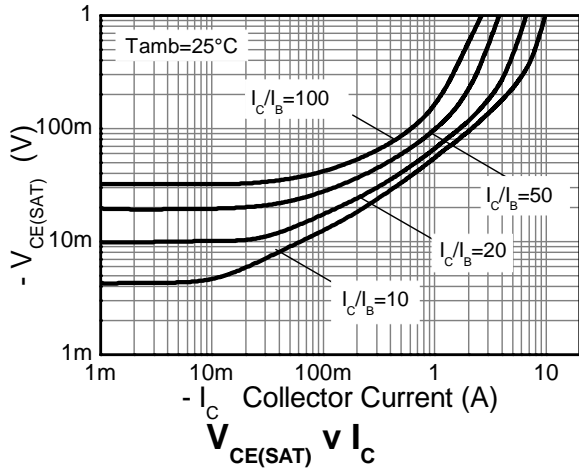

Package Outline Dimensions

Please see AP02002 at <http://www.diodes.com/datasheets/ap02002.pdf> for the latest version.

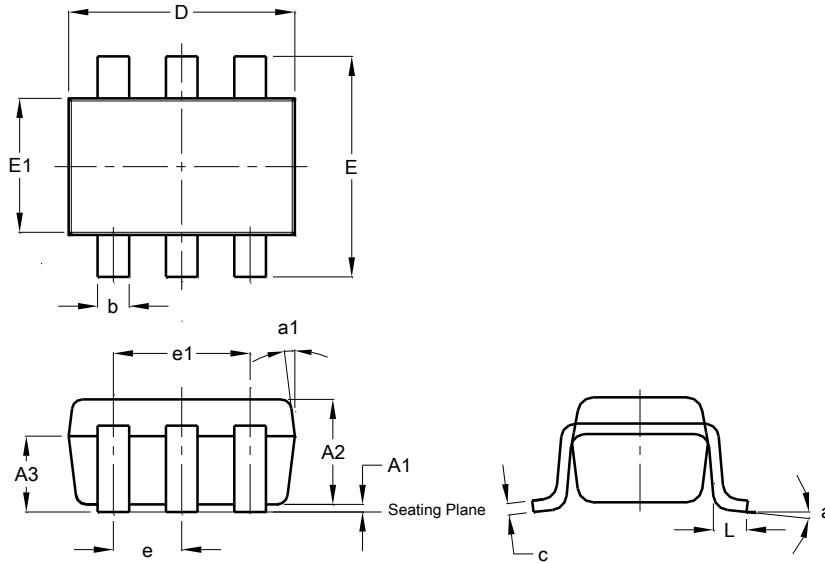

SOT26			
Dim	Min	Max	Typ
A1	0.013	0.10	0.05
A2	1.00	1.30	1.10
A3	0.70	0.80	0.75
b	0.35	0.50	0.38
c	0.10	0.20	0.15
D	2.90	3.10	3.00
e	-	-	0.95
e1	-	-	1.90
E	2.70	3.00	2.80
E1	1.50	1.70	1.60
L	0.35	0.55	0.40
a	-	-	8°
a1	-	-	7°
All Dimensions in mm			

Suggested Pad Layout

Please see AP02001 at <http://www.diodes.com/datasheets/ap02001.pdf> for the latest version.

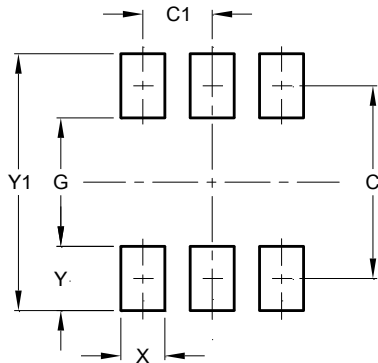

Dimensions	Value (in mm)
C	2.40
C1	0.95
G	1.60
X	0.55
Y	0.80
Y1	3.20

IMPORTANT NOTICE

DIODES INCORPORATED MAKES NO WARRANTY OF ANY KIND, EXPRESS OR IMPLIED, WITH REGARDS TO THIS DOCUMENT, INCLUDING, BUT NOT LIMITED TO, THE IMPLIED WARRANTIES OF MERCHANTABILITY AND FITNESS FOR A PARTICULAR PURPOSE (AND THEIR EQUIVALENTS UNDER THE LAWS OF ANY JURISDICTION).

Diodes Incorporated and its subsidiaries reserve the right to make modifications, enhancements, improvements, corrections or other changes without further notice to this document and any product described herein. Diodes Incorporated does not assume any liability arising out of the application or use of this document or any product described herein; neither does Diodes Incorporated convey any license under its patent or trademark rights, nor the rights of others. Any Customer or user of this document or products described herein in such applications shall assume all risks of such use and will agree to hold Diodes Incorporated and all the companies whose products are represented on Diodes Incorporated website, harmless against all damages.

Diodes Incorporated does not warrant or accept any liability whatsoever in respect of any products purchased through unauthorized sales channel. Should Customers purchase or use Diodes Incorporated products for any unintended or unauthorized application, Customers shall indemnify and hold Diodes Incorporated and its representatives harmless against all claims, damages, expenses, and attorney fees arising out of, directly or indirectly, any claim of personal injury or death associated with such unintended or unauthorized application.

Products described herein may be covered by one or more United States, international or foreign patents pending. Product names and markings noted herein may also be covered by one or more United States, international or foreign trademarks.

This document is written in English but may be translated into multiple languages for reference. Only the English version of this document is the final and determinative format released by Diodes Incorporated.

LIFE SUPPORT

Diodes Incorporated products are specifically not authorized for use as critical components in life support devices or systems without the express written approval of the Chief Executive Officer of Diodes Incorporated. As used herein:

A. Life support devices or systems are devices or systems which:

1. are intended to implant into the body, or
2. support or sustain life and whose failure to perform when properly used in accordance with instructions for use provided in the labeling can be reasonably expected to result in significant injury to the user.

B. A critical component is any component in a life support device or system whose failure to perform can be reasonably expected to cause the failure of the life support device or to affect its safety or effectiveness.

Customers represent that they have all necessary expertise in the safety and regulatory ramifications of their life support devices or systems, and acknowledge and agree that they are solely responsible for all legal, regulatory and safety-related requirements concerning their products and any use of Diodes Incorporated products in such safety-critical, life support devices or systems, notwithstanding any devices- or systems-related information or support that may be provided by Diodes Incorporated. Further, Customers must fully indemnify Diodes Incorporated and its representatives against any damages arising out of the use of Diodes Incorporated products in such safety-critical, life support devices or systems.

Copyright © 2015, Diodes Incorporated

www.diodes.com